



Stratoflex

*Convuluted PTFE Medium Pressure Hose
Products for the Aerospace Industry*

*Catalog 106-3162
August 2001*



The World Standard

DANGER

FAILURE OR IMPROPER SELECTION OR IMPROPER USE OF THE PRODUCTS AND/OR SYSTEMS DESCRIBED HEREIN OR RELATED ITEMS CAN CAUSE DEATH, PERSONAL INJURY AND PROPERTY DAMAGE.

Before selecting or using any Parker hose or fittings or related accessories, it is important that you read and follow Parker Safety Guide for Selecting and Using Hoses, Fittings, and Related Accessories (Parker Publication No. 106-SG)

This document and other information from Parker Hannifin Corporation, its subsidiaries and authorized distributors, provide product and/or system options for further investigation by users having technical expertise. It is important that you analyze all aspects of your application and review the information concerning the product or system in the current product catalog. Due to the variety of operating conditions and applications for these products or systems, the user, through its own analysis and testing, is solely responsible for making the final selection of the products and systems and assuring that all performance, safety and warning requirements of the application are met.

The products described herein, including without limitation, product features, specifications, designs, availability and pricing, are subject to change by Parker Hannifin Corporation and its subsidiaries at any time without notice.

Offer of Sale

The items described in this document are hereby offered for sale by Parker Hannifin Corporation, its subsidiaries or its authorized distributors. This offer and its acceptance are governed by the provisions in the "Offer of Sale".

© 2002 Parker Hannifin Corporation















Parker Hannifin Corporation
Stratoflex Products Division
Fort Worth, Texas

Table of Contents

How to Use This Catalog.....	2
Ordering Information for Standard Items	3-4
Stratoflex "Twist Angle" Information	4
Measurement of Flareless Hose Assemblies.....	4
3162, 3162J, 3164K, Hose	5-7
3162 Hose Fittings (Crimp)	8-10
3162 Flare Hose Assemblies (Crimp)	11-14
3162 Flareless Hose Assemblies (Crimp).....	15-18
Abrasion / Firesleeve Data	19-20
Safety Guide.....	21-22
Offer of Sale	23

How to Use This Catalog

- If you know the type of part (fitting, hose assembly, etc.), see the Table of Contents on page 1.
- The Stratoflex part numbering system for Hose Assemblies is defined on page 3.
- The Stratoflex Hose and Fitting information tables have international symbols as column heads. The symbols and their meaning are noted below.

SYMBOL	DEFINITION	SYMBOL	DEFINITION
#	Part Number		Vacuum Rating
	Hose Inner Diameter		Crimp Fitting
	Hose Outer Diameter		Field Attachable Fitting
	Working Pressure		Page Number
	Burst Pressure		Thread Size
	Minimum Bend Radius		Hex Size
	Weight		Diameter

Order Information for Standard Items

1. HOSE ASSEMBLY:

STRAIGHT TO STRAIGHT (OR STRAIGHT TO SINGLE ELBOW) EXAMPLE:

3162001-8CR-0185

Basic Hose Assembly Number _____ Assembly Length in Inches. Last Digit is Eighths of an Inch.
 Size (1/2" O.D. Tube Size) In 1/16" _____ See Material Note Below

Basic Hose Assembly part numbers may be modified to add a sleeve or coil by the insertion of a code letter between the basic hose number and the configuration. Code letters and accessories described on Pages 25 and 26.

3162F001-8CR-0185

Basic Part Number with 2650-13 Firesleeve and 10781-4-22CR Clamps

DOUBLE ELBOW EXAMPLE: **3162060E0185C180**

Basic Hose Assembly Number _____ Twist Angle (180° - See Page 4)
 Size (1/2" O.D. Tube Size) In 1/16" _____ See Material Note Below
 Assembly Length in Inches. Last Digit is Eighths of an Inch.

SIZE CODE FOR DOUBLE ELBOW HOSE ASSEMBLIES

DASH SIZE	-4	-6	-8	-10	-12	-16	-20	-24	-32
SF CODE LETTER	B	D	E	F	G	H	J	K	L

MATERIAL: Unless otherwise noted, conforms to applicable specifications shown.

C or CR - Non-Brazed/Welded Parts - SAE 30304 (AM5557 or AMS5645) Stainless Steel

CL - Same as CR except lockwire holes in nut.

D - Non-Brazed Parts - SAE2024-T6 (ASM4112) Aluminum

Brazed Parts - SAE 6061-T6 (AMS4117) Aluminum

LENGTH MEASUREMENT - Length is measured along hose centerline from end of nipple to end of nipple.

NOTE: For additional information on special materials or accessories not shown, see pages 25 and 26 or contact Stratoflex.

NOTE: Unless otherwise noted, dimensions shown herein are nominal and are subject to change without notice. Contact Stratoflex Engineering for current data.

2. IDENTIFICATION BANDS: An example of Identification bands used when required for Hose Assemblies confirming AS1055 Type IIb, Class A or B.

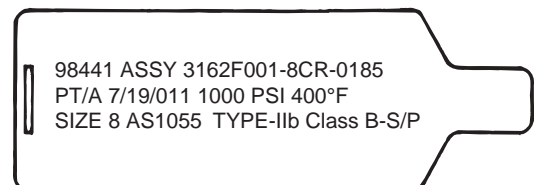

3. Standard length tolerances are:

- Under 18 in.....+.188 / -.125 in.
- 18 in. To 36 in.....+.375 / -.250 in.
- 36 in. To 50 in.....+.750 / -.500 in.
- Over 50 in.....+1.5% / -1%

Ordering Information for Standard Items

STRATOFLEX "TWIST ANGLE" INFORMATION

HOW TO MEASURE AND SPECIFY POSITIONING OF FITTINGS WHEN TWO ELBOW FITTINGS ARE REQUIRED ON A HOSE ASSEMBLY



MEASURING: When installations require hose assemblies with elbow fittings on both ends, hold the assembly so that the nearest fitting is pointing in the 6 o'clock position. Measure angle between fittings, counterclockwise. Both fittings pointing to 6 o'clock to be specified as zero degrees (0°)

SPECIFYING POSITION: Suffix the hose assembly part number with the number of degrees in the angle. (Example: 3162008E0185C180; 180° Twist Angle.)

NOTE: Elbow Hose Fittings shown in this catalog are STRATOFLEX standard type designs. If your installation requires a fitting of a different angle or connection, submit a print for Stratoflex Engineering evaluation.

MEASUREMENT OF FLARELESS HOSE ASSEMBLIES

NAS 1760 Nipple end design is the standard supplied by Stratoflex on flareless hose fittings. Flareless hose assembly length "L" is measured from END of nipple to END of nipple. To convert "END to END" to "GAGE POINT to GAGE POINT" measurement, subtract from "L" the appropriate "B or C" dimension shown in table below for each end fitting. The figures and table below give a comparison of NAS 1760 nipple end design and the Radius Seal end design.

NOTE: ALL HOSE FITTINGS ARE MEASURED AT THE CENTERLINE FOR LENGTH AND DROP DIMENSIONS.

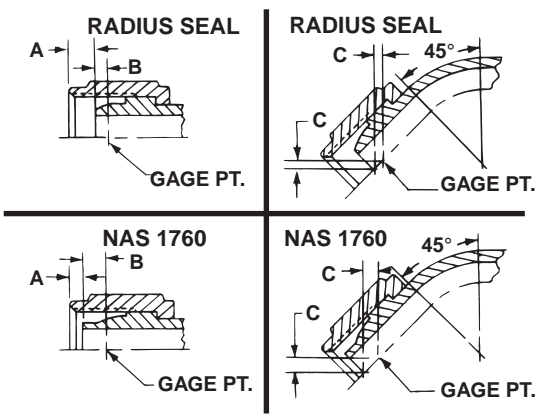

Dash Size	A			B			C		
	NAS	Radius	Diff.	NAS	Radius	Diff.	NAS	Radius	Diff.
3	.123	.138	.015	.140	.085	.055	.099	.060	.039
4	.176	.207	.031	.155	.062	.093	.110	.044	.066
5	.160	.227	.067	.157	.058	.099	.111	.041	.070
6	.173	.198	.025	.164	.059	.105	.116	.042	.074
8	.191	.217	.026	.189	.064	.125	.134	.045	.089
10	.207	.247	.040	.201	.078	.123	.142	.055	.087
12	.206	.303	.097	.228	.069	.159	.161	.049	.112
16	.141	.329	.188	.297	.132	.165	.210	.093	.117
20	.147	.367	.220	.300	.090	.210	.212	.064	.148
24	.077	.330	.253	.365	.134	.231	.258	.095	.163

3162 Convoluted PTFE Hose

3162 Convoluted PTFE Hose

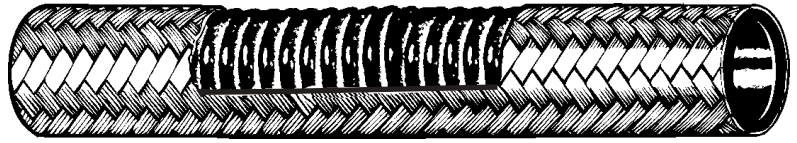

SPECIFICATIONS:

Meets or exceeds the performance requirements of AS620.

CONSTRUCTION:

Tube - Seamless, extruded, convoluted, polytetrafluoroethylene.

Reinforcement - Corrosion-resistant steel wire braid.

APPLICATION:

High temperature aircraft fluid systems. Conductivity conforms to AS620.







PROOF PRESSURE:

Hydrostatic pressure test as noted in table below.

TEMPERATURE RANGE:

-65 to +400°F (-54 to +204°C) with stainless steel fittings.

-65 to +275°F (-54 to +135°C) with aluminum fittings (aluminum fittings are not per AS620 and hose assembly performance is not per AS620. Contact Stratoflex Products Division.)

#	Hose Size	 Minimum	 Maximum	 Bend Radius	Proof Press. (PSI)				 LBS lb/in Nominal
						Min. @ 70°F	Min. @ 400°F		
3162-4	-4	.270	.477	1000	2000	4000	2800	1.25	.007
3162-6	-6	.355	.587	1000	2000	4000	2800	2.25	.010
3162-8	-8	.510	.787	1000	2000	4000	2800	2.88	.015
3162-10	-10	.600	.882	1000	1800	3600	2500	3.00	.020
3162-12	-12	.765	1.092	1000	1800	3600	2500	3.75	.025
3162-16	-16	.970	1.330*	1000	1800	3600	2500	5.00	.030
3162-20	-20	1.220	1.750*	1000	1800	3600	2500	6.25	.056**
3162-24	-24	1.480	2.050*	750	1500	3000	2100	7.50	.067**
3162-32	-32	1.940	2.560*	250	500	1000	700	10.00	.085

* Hose O.D. may exceed AS620 dimension.

** Hose weight may exceed AS620.

BENEFITS

- Tighter bend radius than smooth bore PTFE hose
- Non-aging
- Compatible with most fluids. For specific compatibility information, contact Stratoflex's Fort Worth facility.

3162 Convoluted PTFE Hose

3162J Convoluted Integral Firesleeve PTFE Hose

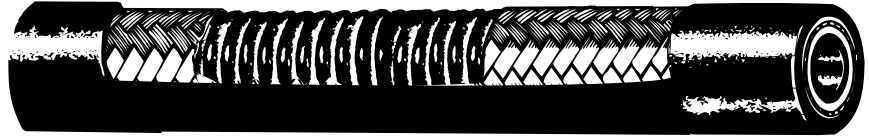

SPECIFICATIONS:

Meets or exceeds the performance requirements of AS620.

CONSTRUCTION:

Tube - Seamless, extruded, convoluted, polytetrafluoroethylene.

Reinforcement - Corrosion-resistant steel wire braid.

Cover: Integral fire resistant silicone.

APPLICATION:

High temperature aircraft fluid systems. Conductivity conforms to AS620.

PROOF PRESSURE:

Hydrostatic pressure test as noted in table below.

TEMPERATURE RANGE:

-65 to +400°F (-54 to +204°C) stainless steel fittings only.

#	Hose Size	Minimum	Maximum *	1000	Proof Press. (PSI)	Min. @ 70°F		Min. @ 400°F	1.25	LBS lb/in Nominal
						4000	2800			
3162-4J	-4	.270	.680	1000	2000	4000	2800	1.25	.016	
3162-6J	-6	.358	.790	1000	2000	4000	2800	2.25	.022	
3162-8J	-8	.510	.990	1000	2000	4000	2800	2.88	.028	
3162-10J	-10	.600	1.085	1000	1800	3600	2500	3.00	.033	
3162-12J	-12	.765	1.295	1000	1800	3600	2500	3.75	.041	
3162-16J	-16	.970	1.530	1000	1800	3600	2500	5.00	.056	
3162-20J	-20	1.220	2.000	1000	1800	3600	2500	6.25	.081	
3162-24J	-24	1.480	2.270	750	1500	3000	2100	7.50	.097	

* Cuff, over fitting(s), will exceed this value.

"J" meets most fire resistance requirements. Consult factory.

BENEFITS

- Better corrosion resistance than non-covered PTFE hose
- Envelope dimensions smaller than conventional "slip over" firesleeve
- No "wicking" as seen with "slip-over" firesleeve
- No end dipping necessary

3162 Convoluted PTFE Hose

3162K Convoluted PTFE Hose with Abrasion Resistant Cover

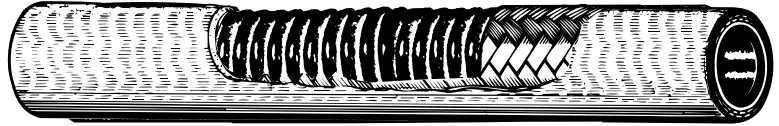

SPECIFICATIONS:

Meets or exceeds the performance requirements of AS620 except maximum sustained temperature.

CONSTRUCTION:

Tube - Seamless, extruded, convoluted, polytetrafluoroethylene.

Reinforcement - Corrosion-resistant steel wire braid.

Cover: Blue braided polyester abrasion resistant.

APPLICATION:

Medium temperature aircraft fluid systems. Conductivity conforms to AS620.

PROOF PRESSURE:

Hydrostatic pressure test as noted in table below.

TEMPERATURE RANGE:

-65 to +300°F (-54 to +149°C) (Sustained temperature limit of polyester cover) with stainless steel fittings.

-65 to +275°F (-54 to 135°C) with aluminum fittings.

#	Hose Size	Minimum	Maximum	1000	Proof Press. (PSI)	Min. @ 70°F		Min. @ 400°F	1.25	LBS lb/in Nominal
						4000	2800			
3162-4K	-4	.270	.597	1000	2000	4000	2800	1.25	*	
3162-6K	-6	.355	.707	1000	2000	4000	2800	2.25	*	
3162-8K	-8	.510	.907	1000	2000	4000	2800	2.88	.020	
3162-10K	-10	.600	1.002	1000	1800	3600	2500	3.00	*	
3162-12K	-12	.765	1.212	1000	1800	3600	2500	3.75	.032	
3162-16K	-16	.970	1.475	1000	1800	3600	2500	5.00	.042	

* To be determined.

BENEFITS

- Added abrasion resistance



3162 PTFE Hose Fittings

412524 Straight Flared Fitting

37° Flare Swivel
Mates with AS4395/MS33656 type connectors.

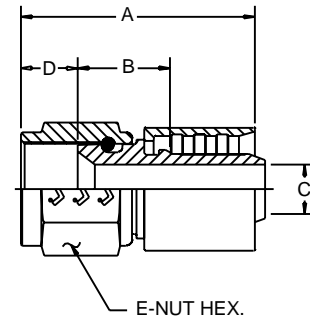
JSA







#	Hose Size		Max. A	Cut Factor B	Min. Thru C	D	 E	 lbs. CR Nominal
412524-4-4CR	-4	7/16-20UNJF-3B	1.46	.50	.125	.35	.56	.050
412524-6-6CR	-6	9/16-18UNJF-3B	1.58	.58	.250	.39	.69	.071
412524-8-8CR*	-8	3/4-16UNJF-3B	1.94	.70	.344	.44	.88	.146
412524L10-10CR*	-10	7/8-14UNJF-3B	2.39	.78	.406	.52	1.00	.234
412524L12-12CR*	-12	1-1/16-12UNJ-3B	2.58	.74	.625	.59	1.25	.371
412524L16-16CR*	-16	1-5/16-12UNJ-3B	2.97	.82	.812	.65	1.50	.540
412524L20-20CR*	-20	1-5/8-12UNJ-3B	3.03	.88	1.062	.64	1.81	.793
412524L24-24CR*	-24	1-7/8-12UNJ-3B	3.48	.98	1.281	.74	2.12	1.227
412524L32-32CR*	-32	2-1/2-12UNJ-3B	3.85	1.11	1.812	.93	2.75	1.985

412526 45° Elbow Flared Fitting

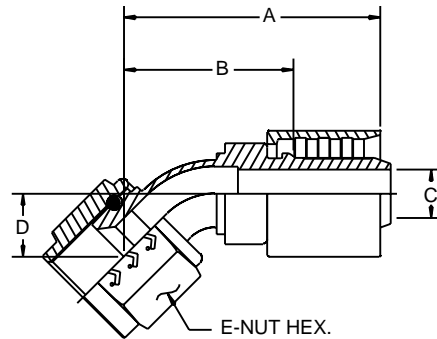
37° Flare Swivel
Mates with AS4395/MS33656 type connectors.

J45S



#	Hose Size		Max. A	Cut Factor B	Min. Thru C	D	 E	 lbs. CR Nominal
412526-4-4CR	-4	7/16-20UNJF-3B	1.52	.93	.094	.36	.56	.059
412526-6-6CR	-6	9/16-18UNJF-3B	1.67	1.08	.219	.46	.69	.084
412526-8-8CR*	-8	3/4-16UNJF-3B	2.03	1.26	.281	.47	.88	.151
412526L10-10CR*	-10	7/8-14UNJF-3B	2.45	1.38	.375	.55	1.00	.290
412526L12-12CR*	-12	1-1/16-12UNJ-3B	2.89	1.56	.562	.63	1.25	.434
412526L16-16CR*	-16	1-5/16-12UNJ-3B	3.18	1.65	.781	.67	1.50	.609
412526L20-20CR*	-20	1-5/8-12UNJ-3B	3.40	1.85	1.000	.78	1.81	.868
412526L24-24CR*	-24	1-7/8-12UNJ-3B	3.82	2.03	1.250	.88	2.12	1.370
412526L32-32CR*	-32	2-1/2-12UNJ-3B	4.23	2.38	1.750	1.08	2.75	2.144

*Add material designation CR for corrosion resistant steel or D for aluminum nipple and nut with a stainless steel socket.



3162 PTFE Hose Fittings

412528 90° Elbow Flared Fitting

37° Flare Swivel

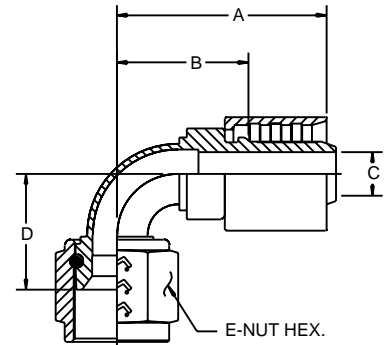
Mates with AS4395/MS33656 type connectors.







#	Hose Size		Max. A	Cut Factor B	Min. Thru C	D	 E	 lbs. CR Nominal
412528-4-4CR	-4	7/16-20UNJF-3B	1.38	.79	.094	.73	.56	.061
412528-6-6CR	-6	9/16-18UNJF-3B	1.50	.91	.219	.94	.69	.088
412528-8-8CR*	-8	3/4-16UNJF-3B	1.86	1.08	.281	.95	.88	.158
412528L10-10CR*	-10	7/8-14UNJF-3B	2.26	1.20	.375	1.14	1.00	.321
412528L12-12CR*	-12	1-1/16-12UNJ-3B	2.75	1.42	.562	1.39	1.25	.452
412528L16-16CR*	-16	1-5/16-12UNJ-3B	3.08	1.59	.781	1.52	1.50	.642
412528L20-20CR*	-20	1-5/8-12UNJ-3B	3.31	1.79	1.000	1.80	1.81	.915
412528L24-24CR*	-24	1-7/8-12UNJ-3B	3.75	1.96	1.250	2.05	2.12	1.493
412528L32-32CR*	-32	2-1/2-12UNJ-3B	4.18	2.33	1.750	2.55	2.75	2.298

412534 Straight Flareless Fitting

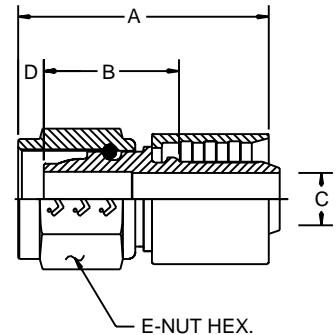
NAS-1760 Flareless Swivel

Mates with AS4375/AS33514 (MS33514) type connectors.



#	Hose Size		Max. A	Cut Factor B	Min. Thru C	D	 E	 lbs. CR Nominal
412534-4-4CR	-4	7/16-20UNJF-3B	1.49	.73	.125	.17	.56	.052
412534-6-6CR	-6	9/16-18UNJF-3B	1.58	.83	.250	.17	.69	.078
412534-8-8CR*	-8	3/4-16UNJF-3B	1.93	.97	.346	.19	.88	.156
412534L10-10CR*	-10	7/8-14UNJF-3B	2.47	1.08	.406	.20	1.00	.248
412534L12-12CR*	-12	1-1/16-12UNJ-3B	2.68	1.14	.625	.20	1.25	.404
412534L16-16CR*	-16	1-5/16-12UNJ-3B	3.03	1.29	.812	.14	1.50	.580
412534L20-20CR*	-20	1-5/8-12UNJ-3B	3.14	1.38	1.002	.15	1.81	.880
412534L24-24CR*	-24	1-7/8-12UNJ-3B	3.57	1.63	1.281	.08	2.12	1.366

*Add material designation CR for corrosion resistant steel or D for aluminum nipple and nut with a stainless steel socket.



Aluminum NOT per AS620.

3162 PTFE Hose Fittings

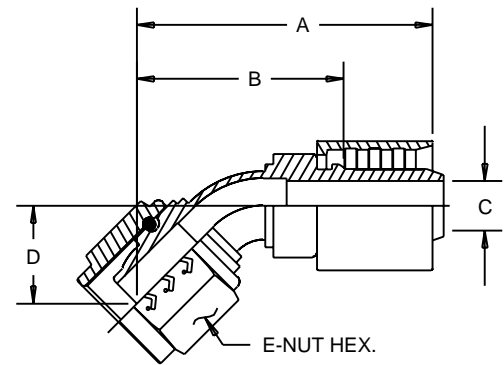
412536 45° Elbow Flareless Fitting





NAS-1760 Flareless Swivel
Mates with AS4375/AS33514 type connectors.

#	Hose Size		Max. A	Cut Factor B	Min. Thru C	D	 E	 lbs. CR Nominal
412536-4-4CR	-4	7/16-20UNJF-3B	1.65	1.10	.094	.53	.56	.062
412536-6-6CR	-6	9/16-18UNJF-3B	1.83	1.28	.219	.66	.69	.091
412536-8-8CR*	-8	3/4-16UNJF-3B	2.24	1.50	.281	.71	.88	.161
412536L10-10CR*	-10	7/8-14UNJ-3B	2.68	1.65	.375	.82	1.00	.315
412536L12-12CR*	-12	1-1/16-12UNJ-3B	3.08	1.84	.562	.92	1.25	.460
412536L16-16CR*	-16	1-5/16-12UNJ-3B	3.30	1.96	.781	.98	1.50	.640
412536L20-20CR*	-20	1-5/8-12UNJ-3B	3.64	2.19	1.000	1.12	1.81	.949
412536L24-24CR*	-24	1-7/8-12UNJ-3B	4.17	2.48	1.250	1.32	2.12	1.480

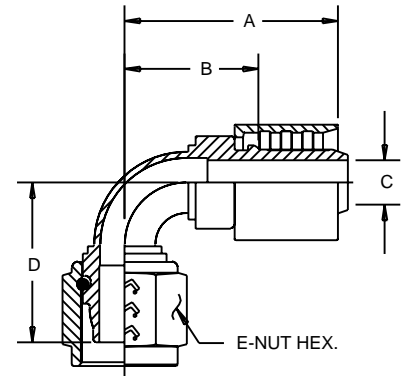
412538 90° Elbow Flareless Fitting



NAS-1760 Flareless Swivel
Mates with AS4375/AS33514 type connectors.

#	Hose Size		Max. A	Cut Factor B	Min. Thru C	D	 E	 lbs. CR Nominal
412538-4-4CR	-4	7/16-20UNJF-3B	1.34	.79	.094	.96	.56	.064
412538-6-6CR	-6	9/16-18UNJF-3B	1.46	.91	.219	1.22	.69	.097
412538-8-8CR*	-8	3/4-16UNJF-3B	1.82	1.08	.281	1.30	.88	.168
412538L10-10CR*	-10	7/8-14UNJF-3B	2.23	1.20	.375	1.52	1.00	.328
412538L12-12CR*	-12	1-1/16-12UNJ-3B	2.66	1.42	.562	1.79	1.25	.478
412538L16-16CR*	-16	1-5/16-12UNJ-3B	2.98	1.54	.781	1.95	1.50	.673
412538L20-20CR*	-20	1-5/8-12UNJ-3B	3.22	1.78	1.000	2.28	1.81	.996
412538L24-24CR*	-24	1-7/8-12UNJ-3B	3.64	1.94	1.250	2.68	2.12	1.603

*Add material designation CR for corrosion resistant steel or D for aluminum nipple and nut with a stainless steel socket.
Aluminum NOT per AS620.

3162 PTFE Hose Assemblies

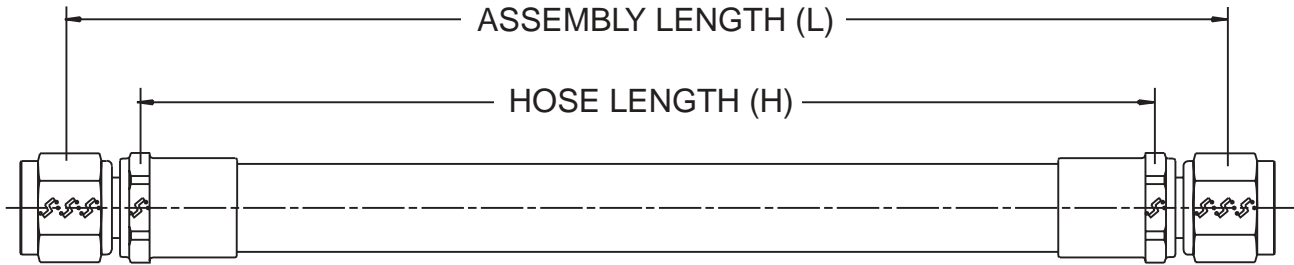

EXAMPLE OF PART NUMBER

3162001-8CR-0185

Assembly Length (L) in Inches. The last digit specifies eighths of an inch.
 Fitting Material Code for corrosion resistant steel. Also available in "D" material. -8 size and above stainless steel socket with all other parts aluminum.
 Size (.500 Tube)
 Basic Part No.

3162F001

Basic Part No. with 2650 Fire Sleeve and 10781 Clamps.

Hose Assemblies with FLARE fittings meet the performance requirements of AS620. Fittings mate with AS4395/MS33656 connection ends. Assembly length measured from END of nipple to END of nipple.

Assemblies with Flare Fittings

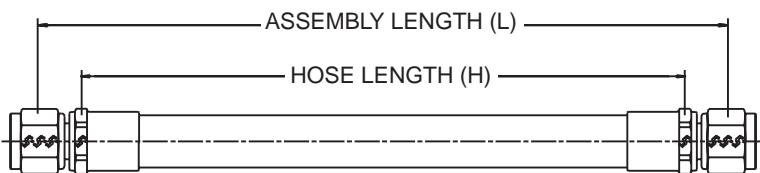

Straight-To-Straight

#	Hose	Left Hand Hose Fitting	Right Hand Hose Fitting		Hose Length H	12" Ass'y Weight lb CR
3162001-4CR-L	3162-4	412524-4-4CR	412524-4-4CR	1.25	L-1.00	.177
3162001-6CR-L	3162-6	412524-6-6CR	412524-6-6CR	2.25	L-1.16	.250
3162001-8CR-L	3162-8	412524-8-8CR	412524-8-8CR	2.88	L-1.40	.471
3162001-10CR-L	3162-10	412524L10-10CR	412524L10-10CR	3.00	L-1.56	.677
3162001-12CR-L	3162-12	412524L12-12CR	412524L12-12CR	3.75	L-1.48	1.005
3162001-16CR-L	3162-16	412524L16-16CR	412524L16-16CR	5.00	L-1.64	1.391
3162001-20CR-L	3162-20	412524L20-20CR	412524L20-20CR	6.25	L-1.76	2.159
3162001-24CR-L	3162-24	412524L24-24CR	412524L24-24CR	7.50	L-1.96	3.127
3162001-32CR-L	3162-32	412524L32-32CR	412524L32-32CR	10.00	L-2.22	4.801

AS4499

Weights shown are nominal for basic hose with CR fittings; guaranteed maximum is normally 110% of value shown.

3162 PTFE Flare Hose Assemblies

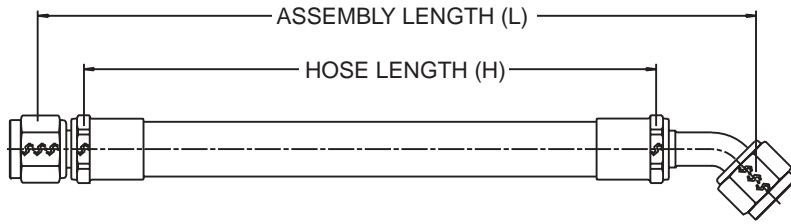

Straight-To-45° Elbow

#	Hose	Left Hand Hose Fitting	Right Hand Hose Fitting		Hose Length H	12" Ass'y Weight lb
3162003-4CR-L	3162-4	412524-4-4CR	412526-4-4CR	1.25	L-1.43	.183
3162003-6CR-L	3162-6	412524-6-6CR	412526-6-6CR	2.25	L-1.66	.258
3162003-8CR-L	3162-8	412524-8-8CR	412526-8-8CR	2.88	L-1.96	.448
3162003-10CR-L	3162-10	412524L10-10CR	412526L10-10CR	3.00	L-2.16	.721
3162003-12CR-L	3162-12	412524L12-12CR	412526L12-12CR	3.75	L-2.30	1.048
3162003-16CR-L	3162-16	412524L16-16CR	412526L16-16CR	5.00	L-2.47	1.439
3162003-20CR-L	3162-20	412524L20-20CR	412526L20-20CR	6.25	L-2.73	2.180
3162003-24CR-L	3162-24	412524L24-24CR	412526L24-24CR	7.50	L-3.01	3.199
3162003-32CR-L	3162-32	412524L32-32CR	412526L32-32CR	10.00	L-3.49	4.852

AS4500

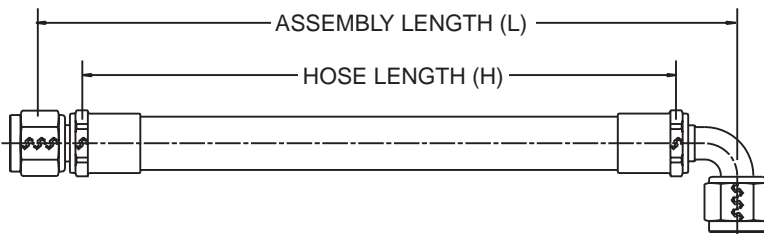

Straight-To-90° Elbow

#	Hose	Left Hand Hose Fitting	Right Hand Hose Fitting		Hose Length H	12" Ass'y Weight lb
3162005-4CR-L	3162-4	412524-4-4CR	412528-4-4CR	1.25	L-1.29	.186
3162005-6CR-L	3162-6	412524-6-6CR	412528-6-6CR	2.25	L-1.49	.264
3162005-8CR-L	3162-8	412524-8-8CR	412528-8-8CR	2.88	L-1.78	.457
3162005-10CR-L	3162-10	412524L10-10CR	412528L10-10CR	3.00	L-1.98	.755
3162005-12CR-L	3162-12	412524L12-12CR	412528L12-12CR	3.75	L-2.16	1.069
3162005-16CR-L	3162-16	412524L16-16CR	412528L16-16CR	5.00	L-2.41	1.470
3162005-20CR-L	3162-20	412524L20-20CR	412528L20-20CR	6.25	L-2.67	2.230
3162005-24CR-L	3162-24	412524L24-24CR	412528L24-24CR	7.50	L-2.94	3.327
3162005-32CR-L	3162-32	412524L32-32CR	412528L32-32CR	10.00	L-3.44	5.011

AS4501

Weights shown are nominal for basic hose with CR fittings; guaranteed maximum is normally 110% of value shown.

3162 PTFE Flare Hose Assemblies

Assemblies with Double Elbow Flare Fittings

EXAMPLE OF PART NUMBER

3162006E0185C180

Basic Part No.

Twist Angle (*) In Degrees. See page 4.

Fitting Material Code

Assembly Length (L) in Inches. The last digit specifies eighths of an inch.

SIZE CODE FOR DOUBLE ELBOW HOSE ASSEMBLIES

3162F006

Hose Dash Size	-4	-6	-8	-10	-12	-16	-20	-24	-32
Letter Code	B	D	E	F	G	H	J	K	L

Basic Part Number with 2650 Fire Sleeve and 10781 Clamps.

Assembly length measured from END of nipple to END of nipple.

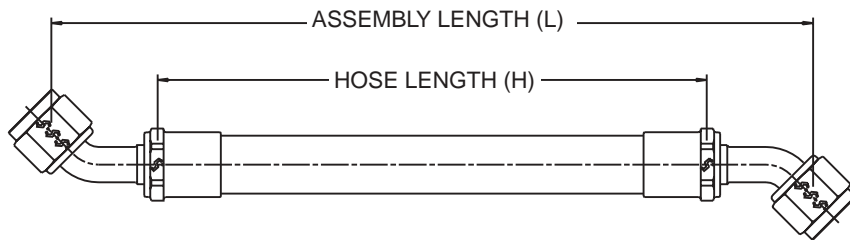

45° Elbow-to-45°-Elbow

#	Hose	Left Hand Hose Fitting	Right Hand Hose Fitting		Cut Length H	12" Ass'y Weight lb
3162006B(L)C*	3162-4	412526-4-4CR	412526-4-4CR	1.25	L-1.86	.189
3162006D(L)C*	3162-6	412526-6-6CR	412526-6-6CR	2.25	L-2.16	.266
3162006E(L)C*	3162-8	412526-8-8CR	412526-8-8CR	2.88	L-2.52	.444
3162006F(L)C*	3162-10	412526L10-10CR	412526L10-10CR	3.00	L-2.76	.765
3162006G(L)C*	3162-12	412526L12-12CR	412526L12-12CR	3.75	L-3.12	1.090
3162006H(L)C*	3162-16	412526L16-16CR	412526L16-16CR	5.00	L-3.30	1.479
3162006J(L)C*	3162-20	412526L20-20CR	412526L20-20CR	6.25	L-3.70	2.201
3162006K(L)C*	3162-24	412526L24-24CR	412526L24-24CR	7.50	L-4.06	3.272
3162006L(L)C*	3162-32	412526L32-32CR	412526L32-32CR	10.00	L-4.76	4.903

AS4502

Similar as AS4502 except fitting drop and tangent length.

*Twist Angle. See page 4.

Weights shown are nominal for basic hose with CR fittings; guaranteed maximum is normally 110% of value shown.

Aluminum/CRES fittings available.

3162 PTFE Flare Hose Assemblies

Assemblies with Double Elbow Flare Fittings

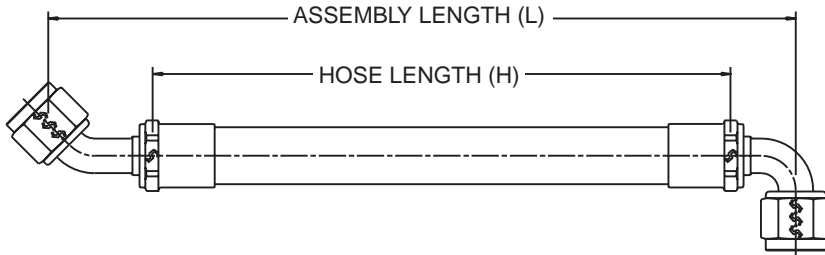

45° Elbow-To-90° Elbow

#	Hose	Left Hand Hose Fitting	Right Hand Hose Fitting		Hose Length H	12" Ass'y Weight lb
3162007B(L)C*	3162-4	412526-4-4CR	412528-4-4CR	1.25	L-1.72	.192
3162007D(L)C*	3162-6	412526-6-6CR	412528-6-6CR	2.25	L-1.99	.272
3162007E(L)C*	3162-8	412526-8-8CR	412528-8-8CR	2.88	L-2.34	.454
3162007F(L)C*	3162-10	412526L10-10CR	412528L10-10CR	3.00	L-2.58	.799
3162007G(L)C*	3162-12	412526L12-12CR	412528L12-12CR	3.75	L-2.98	1.112
3162007H(L)C*	3162-16	412526L16-16CR	412528L16-16CR	5.00	L-3.24	1.514
3162007J(L)C*	3162-20	412526L20-20CR	412528L20-20CR	6.25	L-3.64	2.251
3162007K(L)C*	3162-24	412526L24-24CR	412528L24-24CR	7.50	L-3.99	3.400
3162007L(L)C*	3162-32	412526L32-32CR	412528L32-32CR	10.00	L-4.71	5.062

AS4503

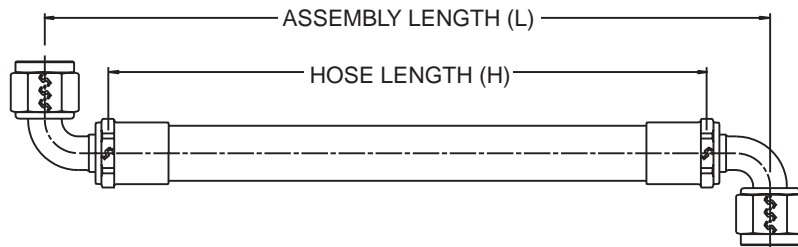

90° Elbow-To-90° Elbow

#	Hose	Left Hand Hose Fitting	Right Hand Hose Fitting		Hose Length H	12" Ass'y Weight lb
3162008B(L)C*	3162-4	412528-4-4CR	412528-4-4CR	1.25	L-1.58	.195
3162008D(L)C*	3162-6	412528-6-6CR	412528-6-6CR	2.25	L-1.82	.278
3162008E(L)C*	3162-8	412528-8-8CR	412528-8-8CR	2.88	L-2.16	.464
3162008F(L)C*	3162-10	412528L10-10CR	412528L10-10CR	3.00	L-2.40	.834
3162008G(L)C*	3162-12	412528L12-12CR	412528L12-12CR	3.75	L-2.84	1.133
3162008H(L)C*	3162-16	412528L16-16CR	412528L16-16CR	5.00	L-3.18	1.549
3162008J(L)C*	3162-20	412528L20-20CR	412528L20-20CR	6.25	L-3.58	2.302
3162008K(L)C*	3162-24	412528L24-24CR	412528L24-24CR	7.50	L-3.92	3.527
3162008L(L)C*	3162-32	412528L32-32CR	412528L32-32CR	10.00	L-4.66	5.220

AS4504

*Twist Angle. See page 4.

Weights shown are nominal for basic hose with CR fittings; guaranteed maximum is normally 110% of value shown.

Aluminum/CRES fittings available.

3162 PTFE Flareless Hose Assemblies

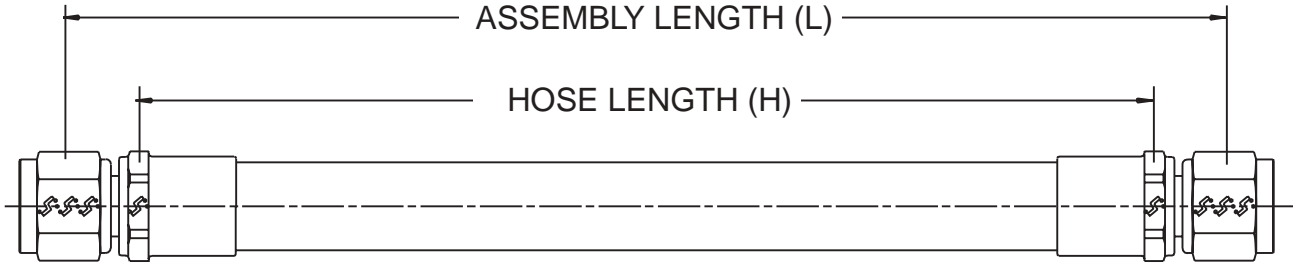

EXAMPLE OF PART NUMBER

3162010-8CR-0185

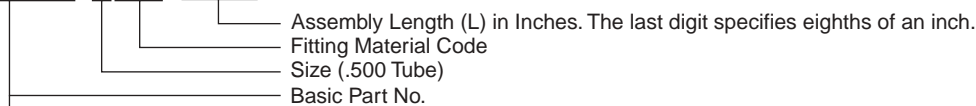

3162F010

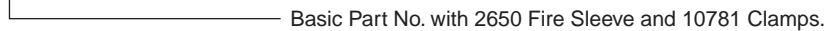

Hose Assemblies with FLARELESS fittings meet the performance requirements of AS620. Fittings mate with AS4375/AS33514 (MS33514) type connectors. Assembly length measured from END of nipple to END of nipple. See "MEASUREMENT OF FLARELESS HOSE ASSEMBLIES" (page 4) to convert to GAGE POINT to GAGE POINT assembly length.

Assemblies with Flareless Fittings

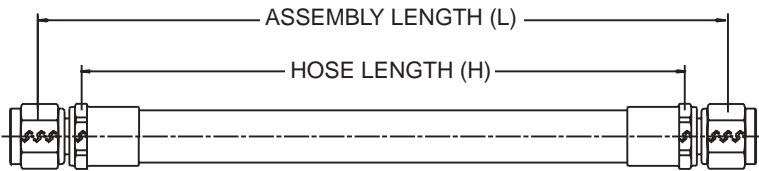

Straight-To-Straight

#	Hose	Left Hand Hose Fitting	Right Hand Hose Fitting		Hose Length H	12" Ass'y Weight lb
3162010-4CR-L	3162-4	412534-4-4CR	412534-4-4CR	1.25	L-1.46	.177
3162010-6CR-L	3162-6	412534-6-6CR	412534-6-6CR	2.25	L-1.66	.258
3162010-8CR-L	3162-8	412534-8-8CR	412534-8-8CR	2.88	L-1.94	.461
3162010-10CR-L	3162-10	412534L10-10CR	412534L10-10CR	3.00	L-2.16	.693
3162010-12CR-L	3162-12	412534L12-12CR	412534L12-12CR	3.75	L-2.28	1.051
3162010-16CR-L	3162-16	412534L16-16CR	412534L16-16CR	5.00	L-2.58	1.443
3162010-20CR-L	3162-20	412534L20-20CR	412534L20-20CR	6.25	L-2.76	2.277
3162010-24CR-L	3162-24	412534L24-24CR	412534L24-24CR	7.50	L-3.26	3.318

AS1633

AS1633 is measured gage pt. to gage pt. See page 4.

Weights shown are nominal for basic hose with CR fittings; guaranteed maximum is normally 110% of value shown.

Aluminum/CRES fittings available.

3162 PTFE Flareless Hose Assemblies

Assemblies with Flareless Fittings

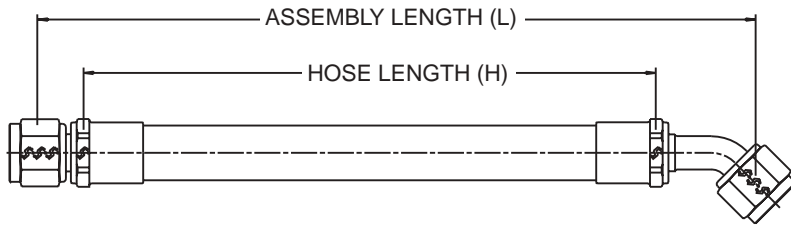

Straight-To-45° Elbow

#	Hose	Left Hand Hose Fitting	Right Hand Hose Fitting		Hose Length H	12" Ass'y Weight lb
3162011-4CR-L	3162-4	412534-4-4CR	412536-4-4CR	1.25	L-1.83	.185
3162011-6CR-L	3162-6	412534-6-6CR	412536-6-6CR	2.25	L-2.11	.267
3162011-8CR-L	3162-8	412534-8-8CR	412536-8-8CR	2.88	L-2.47	.459
3162011-10CR-L	3162-10	412534L10-10CR	412536L10-10CR	3.00	L-2.73	.746
3162011-12CR-L	3162-12	412534L12-12CR	412536L12-12CR	3.75	L-2.98	1.087
3162011-16CR-L	3162-16	412534L16-16CR	412536L16-16CR	5.00	L-3.25	1.479
3162011-20CR-L	3162-20	412534L20-20CR	412536L20-20CR	6.25	L-3.57	2.319
3162011-24CR-L	3162-24	412534L24-24CR	412536L24-24CR	7.50	L-4.11	3.375

AS1634

AS1634 is measured gage pt. to gage pt. See page 4.

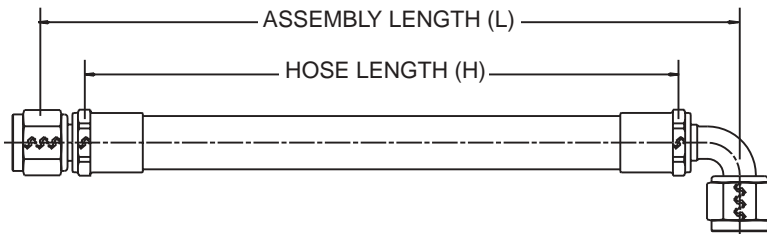

Straight-To-90° Elbow

#	Hose	Left Hand Hose Fitting	Right Hand Hose Fitting		Hose Length H	12" Ass'y Weight lb
3162012-4CR-L	3162-4	412534-4-4CR	412538-4-4CR	1.25	L-1.52	.189
3162012-6CR-L	3162-6	412534-6-6CR	412538-6-6CR	2.25	L-1.74	.277
3162012-8CR-L	3162-8	412534-8-8CR	412538-8-8CR	2.88	L-2.05	.472
3162012-10CR-L	3162-10	412534L10-10CR	412538L10-10CR	3.00	L-2.28	.768
3162012-12CR-L	3162-12	412534L12-12CR	412538L12-12CR	3.75	L-2.56	1.115
3162012-16CR-L	3162-16	412534L16-16CR	412538L16-16CR	5.00	L-2.83	1.525
3162012-20CL-L	3162-20	412534L20-20CR	412538L20-20CR	6.25	L-3.16	2.371
3162012-24CL-L	3162-24	412534L24-24CR	412538L24-24CR	7.50	L-3.57	3.534

AS1635

AS1635 is measured gage pt. to gage pt. See page 4.

.Weights shown are nominal for basic hose with CR fittings; guaranteed maximum is normally 110% of value shown.

Aluminum/CRES fittings available.

3162 PTFE Flareless Hose Assemblies

EXAMPLE OF PART NUMBER

3162013E0185C180

Basic Part No.

Twist Angle (*) In Degrees. See page 4.

Fitting Material Code

Assembly Length (L) in Inches. The last digit specifies eighths of an inch.

SIZE CODE FOR DOUBLE ELBOW HOSE ASSEMBLIES

3162F013

Hose Dash Size	-4	-6	-8	-10	-12	-16	-20	-24	-32
Letter Code	B	D	E	F	G	H	J	K	L

Basic Part Number
with 2650 Fire Sleeve
and 10781 Clamps.

Assembly length measured from END of nipple to END of nipple. See "MEASUREMENT OF FLARELESS ASSEMBLIES" (Page 4) to convert to GAGE POINT to GAGE POINT assembly length.

Assemblies with Double Elbow Flareless Fittings

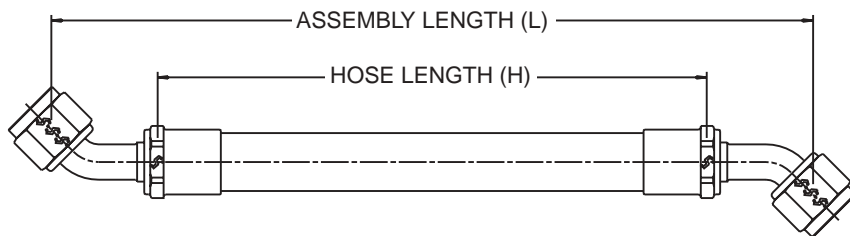

45° Elbow-to-45°-Elbow

#	Hose	Left Hand Hose Fitting	Right Hand Hose Fitting		Hose Length H	12" Ass'y Weight lb
3162013B(L)C*	3162-4	412536-4-4CR	412536-4-4CR	1.25	L-2.20	.193
3162013D(L)C*	3162-6	412536-6-6CR	412536-6-6CR	2.25	L-2.56	.276
3162013E(L)C*	3162-8	412536-8-8CR	412536-8-8CR	2.88	L-3.00	.457
3162013F(L)C*	3162-10	412536L10-10CR	412536L-10-10CR	3.00	L-3.30	.804
3162013G(L)C*	3162-12	412536L12-12CR	412536L-12-12CR	3.75	L-3.68	1.128
3162013H(L)C*	3162-16	412536L16-16CR	412536L-16-16CR	5.00	L-3.92	1.522
3162013J(L)C*	3162-20	412536L20-20CR	412536L-20-20CR	6.25	L-4.38	2.325
3162013K(L)C*	3162-24	412536L24-24CR	412536L-24-24CR	7.50	L-4.96	3.432

AS1636

*Twist Angle. See page 4.

AS1636 is measured gage pt. to gage pt. See page 4.

Weights shown are nominal for basic hose with CR fittings; guaranteed maximum is normally 110% of value shown.

Aluminum/CRES fittings available.

3162 PTFE Flareless Hose Assemblies

Assemblies with Double Elbow Flareless Fittings

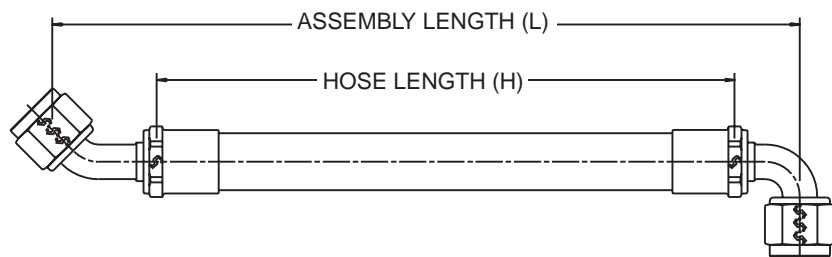

45° Elbow-To-90° Elbow

#	Hose	Left Hand Hose Fitting	Right Hand Hose Fitting		Hose Length H	12" Ass'y Weight lb
3162014B(L)C*	3162-4	412536-4-4CR	412538-4-4CR	1.25	L-1.89	.197
3162014D(L)C*	3162-6	412536-6-6CR	412538-6-6CR	2.25	L-2.19	.286
3162014E(L)C*	3162-8	412536-8-8CR	412538-8-8CR	2.88	L-2.58	.470
3162014F(L)C*	3162-10	412536L10-10CR	412538L10-10CR	3.00	L-2.85	.826
3162014G(L)C*	3162-12	412536L12-12CR	412538L12-12CR	3.75	L-3.26	1.157
3162014H(L)C*	3162-16	412536L16-16CR	412538L16-16CR	5.00	L-3.50	1.568
3162014J(L)C*	3162-20	412536L20-20CR	412538L20-20CR	6.25	L-3.97	2.395
3162014K(L)C*	3162-24	412536L24-24CR	412538L24-24CR	7.50	L-4.42	3.591

AS1637

AS1637 is measured gage pt. to gage pt. See page 4.

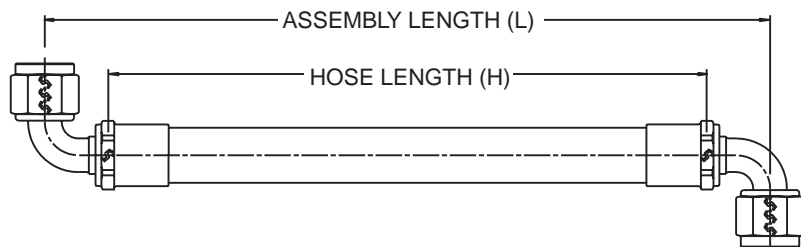

90° Elbow-To-90° Elbow

#	Hose	Left Hand Hose Fitting	Right Hand Hose Fitting		Hose Length H	12" Ass'y Weight lb
3162015B(L)C*	3162-4	412538-4-4CR	412538-4-4CR	1.25	L-1.58	.201
3162015D(L)C*	3162-6	412538-6-6CR	412538-6-6CR	2.25	L-1.82	.296
3162015E(L)C*	3162-8	412538-8-8CR	412538-8-8CR	2.88	L-2.16	.484
3162015F(L)C*	3162-10	412538L10-10CR	412538L10-10CR	3.00	L-2.40	.848
3162015G(L)C*	3162-12	412538L12-12CR	412538L12-12CR	3.75	L-2.84	1.185
3162015H(L)C*	3162-16	412538L16-16CR	412538L16-16CR	5.00	L-3.08	1.614
3162015J(L)C*	3162-20	412538L20-20CR	412538L20-20CR	6.25	L-3.56	2.465
3162015K(L)C*	3162-24	412538L24-24CR	412538L24-24CR	7.50	L-3.88	3.750

AS1638

*Twist Angle. See page 4.

AS1638 is measured gage pt. to gage pt. See page 4.

Weights shown are nominal for basic hose with CR fittings; guaranteed maximum is normally 110% of value shown.

Aluminum/CRES fittings available.

Coil and Sleeve Accessories

FIRE SLEEVED TYPE HOSE ASSEMBLIES



2650 FIRESLEEVE CODE F
Red Silicone Fiberglass -65° to 450°F (-54° to 232°C)
AS1072 SIL

NOTE: Temperature rating is for Firesleeve only.
Request P-104-29 for assembly instructions.

INTERNALLY SUPPORTED TYPE HOSE ASSEMBLIES



2611 INTERNAL SUPPORT COIL CODE C
Corrosion Resistant Steel SAE 30302/AMS5688

Request P-104-41 for assembly instructions.

TUBULAR ABRASION SLEEVES



2606 CODE V
TRANSLUCENT VINYL
-90° to 158°F (-68° to 70°C)
MIL-I-7444 TYPE I CLASS I



2637-SIZE B CODE T
BLACK TFE
-65° to 450°F (-54° to 232°C)
AS1291-B

HEAT SHRINK ABRASION SLEEVES



2629 CODE M
BLACK POLYOLEFIN
-67° to 275°F (-55° to 135°C)
AS1073-B and SAE-AMS-DTL-23053/5



2642 CODE Z
TRANSPARENT FEP TFE
-88° to 392°F (-67° to 200°C)
SAE-AMS-DTL-23053/11

FIRE SLEEVE CLAMP

Fire Sleeve Clamp Versus
Hose Assembly Size



Hose	10781		
	-4-22CR	-4-32CR	-4-48CR
111	-3/-8	-10/-16	-20/-32
112	-4/-8	-10/-12	-16
124	-6/-12	-16Z/-20Z	-24Z
156	-4/-10	-12/-16	-20/-32
170	-4/-10	-12/-16	
171	-4/-10	-12	
193	-4/-10		
3162	-4/-10	-12/-16	

SPIRAL WRAP ABRASION SLEEVES



2661-SIZE NB CODE X
BLACK NYLON
-65° to 300°F (-54° to 149°C)
AS1294



2681 CODE U
BLACK TFE
-65° to 450°F (-54° to 232°C)
AS1293

3162 PTFE Hose and Fittings

Hose or Sleeve

Code	Type	Part No.	Hose Size Max. O.D. in BOLD type. Max. weight hose and sleeve - lbs. per inch in <i>ITALICS</i> type.								
			-4	-6	-8	-10	-12	-16	-20	-24	-32
None	Hose only.	3162	.477 .007	.587 .010	.787 .015	.882 .020	1.092 .025	1.330 .030	1.750 .056	2.050 .067	2.560 .085
* J	Hose with integral extruded brown silicone fire cover designed to meet the fire resistance requirements.	3162-Size J	.680 .016	.790 .022	.990 .028	1.085 .033	1.295 .041	1.530 .056	2.000 .081	2.270 .097	- -
K	Hose with braided polyester abrasion cover, blue.	3162-Size K	.597	.707	.907 .020	1.002	1.212 .032	1.475 .042	- -	- -	- -
F	2650 Red silicone-fiberglass FIRE SLEEVE enables hose assemblies to meet fire resistance requirements.	2650-SIZE	.90 .0203	1.03 .0275	1.15 .0358	1.38 .0475	1.59 .0558	1.90 .0700	2.06 .0910	2.032 .1070	3.100 .1485
M	Shrink abrasion sleeve (black), per AS1073 and MIL-I-23053/5. Polyolefin. Temperature limit 275°F.	2629-SIZE	.547 .0085	.657 .0115	.867 .0171	.974 .0236	1.184 .0286	1.434 .0356	1.842 .0607	2.166 .0762	2.676 .0942
U	Spiral abrasion sleeve, black per AS1293, TFE.	2681-SIZE	.579 N/A	.689 N/A	.889 N/A	.984 N/A	- -	- -	- -	- -	- -
T	Tubular abrasion sleeve (black), per AS1291B. TFE/FEP.	2637-SIZE B	.537 .0104	.670 .0141	.867 .0190	1.020 .0246	1.170 .0306	1.420 .0371	1.830 .0644	- -	- -
V	Tubular abrasion sleeve (translucent), Per MIL-I-7444 Type I Class 1. Vinyl. Temperature limit 158°F.	2606-SIZE	.533 .0088	.657 .0128	.867 .0193	.962 .0250	1.172 .0308	1.420 .0382	1.876 .0717	2.190 .0866	2.720 .1086
GR	Spiral abrasion sleeve (black), per AS1294. Nylon.	2661-SIZE NB	.557 .0091	.667 .0121	.851 .0198	.946 .0242	1.156 .0302	- -	- -	- -	- -
MR	Spiral abrasion sleeve (transparent) Per MIL-I-23053/11. FEP.	2642-SIZE	.525 .0096	.635 .0138	.845 .0197	.950 .0268	1.170 .0357	1.408 .0409	1.828 .0700	2.098 .0850	2.608 .1050

*Dimension(s) and weight(s) shown are "J"; see page 6.

Coils and Sleeves Size(s) Reference Only

Letter Code	F	M	T	U	V	GR	MR
Hose Part No.	** Silicone Fiberglass Firesleeve	Polyolefin Shrink Sleeve	TFE Abrasion Sleeve	TFE Spiral Wrap	Vinyl Abrasion Sleeve	Nylon Spiral Wrap	TFE Shrink Sleeve
3162-4	2650-9	2629-28	2637-15B	2681-11	2606-7	2661-16NB	2642-14
3162-6	2650-11	2629-28	2637-19B	2681-15	2606-9	2661-16NB	2642-18
3162-8	2650-13	2629-32	2637-24B	2681-15	2606-12	2661-24NB	2642-20
3162-10	2650-16	2629-48	2637-30B	2681-15	2606-14	2661-28NB	2642-24
3162-12	2650-20	2629-48	2627-36B	-	2606-16	2661-32NB	2642-32
3162-16	2650-24	2629-64	2637-42B	-	2606-20	2661-40NB	2642-41
3162-20	2650-28	2629-74	2637-56B	-	2606-28	-	2642-48
3162-24	2650-32	2629-96	-	-	2606-32	-	2642-65
3162-32	2650-44	2629-96	-	-	2606-40	-	2642-80

**Size(s) per HS2650 only for TSO, AS1055 compliance.

Parker Safety Guide for Selecting and Using Hose, Tubing, Fittings and Related Accessories



DANGER: Failure or improper selection or improper use of hose, fittings, or related accessories can cause death, personal injury and property damage. Possible consequences of failure or improper selection or improper use of hose, fittings, or related accessories include but are not limited to:

- Explosion or burning of the conveyed fluid.
- Contact with conveyed fluids, hot, cold, toxic and injurious.
- Dangerously whipping hose.
- Loss of control system.
- High velocity fluid discharge.
- Fittings thrown off at high speed.
- Injection by high-pressure fluid discharge.

Before selecting or using any Parker Hose or Fittings or related accessories, it is important that you read and follow the instructions below.

1.0 GENERAL INSTRUCTIONS

- 1.1 Scope:** This safety guide provides instructions for selecting and using (including assembling, installing, and maintaining) hose (including all rubber *and/or* PTFE products commonly called "hose" or "tubing"), fittings (including all products commonly called "fittings" or "couplings" for attachment to hose), and related accessories (including crimping and swaging machines and tooling). This safety guide is a supplement to and is to be used with, the specific Parker publications for the specific hose, fittings and related accessories that are being considered for use.
- 1.2 Fail-Safe:** Hose and hose assemblies can and do fail without warning for many reasons. Design all systems and equipment in a fail-safe mode, so that failure of the hose or hose assembly will not endanger persons or property.
- 1.3 Distribution:** Provide a copy of this safety guide to each person that is responsible for selecting or using hose and fitting products. Do not select or use hose and fittings without thoroughly reading and understanding this safety guide as well as the specific Parker publications for the products considered or selected.
- 1.4 User Responsibility:** Due to the wide variety of operating conditions and uses for hose and fittings, Parker and its distributors do not represent or warrant that any particular hose or fitting is suitable for any specific end use system. Most Parker Stratoflex Products Division products are qualified to Military or Industry Standards. This safety guide does not analyze all technical parameters that must be considered in selecting a product. The user, through its own analysis and testing, is solely responsible for:
- Making the final selection of the hose and fitting.
 - Assuring that the user's requirements are met and that the use presents no health or safety hazards.
 - Providing all appropriate health and safety warnings on the equipment on which the hose and fittings are used.
- 1.5 Additional Questions:** Call the appropriate Parker technical service department if you have any questions or require any additional information. See the Parker publication for the product being considered or used, for telephone numbers of the appropriate technical service department.

2.0 HOSE AND FITTING SELECTION INSTRUCTIONS

- 2.1 Electrical Conductivity:** Certain applications require that a hose be nonconductive to prevent electrical current flow or maintain electrical isolation. Other applications require the hose to be sufficiently conductive to drain off static electricity; this is typical of rubber hose and of all aerospace fuel, oil and hydraulic PTFE hose. Extreme care must be exercised when selecting hose and fittings for these or any other applications in which electrical conductivity or non-conductivity is a factor.
- For applications that require hose to be electrically nonconductive, only special nonconductive hose can be used. The manufacturer of the equipment in which the nonconductive hose is to be used must be consulted to be certain that the hose and fittings that are selected are proper for the application. Do not use any Parker hose or fitting for any such application requiring nonconductive hose unless (i) the application is expressly approved in the Parker technical publication for the product, (ii) the manufacturer of the equipment on which the hose is to be used specifically approves the particular Parker hose and fitting for such use.
- The electrical conductivity or non-conductivity of hose and fittings is dependent upon many factors and may be susceptible to change. These factors include but are not limited to the various materials, including fitting finish, used to make the hose and the fittings, how the fittings contact the hose, age and amount of deterioration or damage or other changes and other factors. Aluminum fitting finish effects "conductivity"; anodize is non-conductive, while alodine is conductive.
- 2.2 Pressure:** Hose selection must be made so that the published maximum recommended working pressure of the hose is equal to or greater than the maximum system pressure. Surge pressures in the system higher than the published maximum recommended working pressure would cause failure or shorten hose life. Do not confuse burst pressure or other pressure values with working pressure and do not use burst pressure or other pressure values for this purpose.

Hose assemblies are "proof pressure" tested (normally 2 x working rated pressure) to confirm proper fabrication of the assembly. Gaseous test, including air-under-water, shall be at rated working pressure only and see 4.7 caution below. Care must be exercised to prevent water, or other fluid contaminants from unnecessarily contacting reinforcement, etc.

- 2.3 Suction:** Hoses used for suction applications must be selected to insure that the hose will withstand the vacuum and pressure of the system. Improperly selected hose may collapse in suction application.
- 2.4 Temperature:** Be certain that fluid and ambient temperatures, both steady and transient, do not exceed the limitations of the hose. Temperatures below and above the recommended limit can degrade hose to a point where a failure may occur and release fluid. Care must be taken when routing hose near hot objects (e.g. manifolds) to properly insulate and protect the hose. Fire sleeve is not intended as insulation.
- 2.5 Fluid Compatibility:** Hose selection must assure compatibility of the hose tube, cover, reinforcement, and fittings with the fluid media used. Actual service life can only be determined by the end user by history or testing under all extreme conditions and other analysis.
- 2.6 Permeation:** Permeation (that is, seepage through the hose) may occur from inside the hose to outside when hose is used with gases, liquid and gas fuels, and refrigerants (including but not limited to such materials as helium, fuel oil, natural gas, or refrigerant). This permeation may result in high concentrations of vapors, which are potentially flammable, explosive, or toxic, and in loss of fluid. Dangerous explosions, fires, and other hazards can result when using the wrong hose for such applications. The system designer must take into account the fact that this permeation will take place and must not use hose if this permeation could be hazardous. The system designer must take into account all legal, government, insurance, or any other special regulations, which govern the use of fuels and refrigerants. Never use a hose even though the fluid compatibility is acceptable without considering the potential hazardous effects that can result from permeation through the hose assembly.
- Gaseous permeation, particularly through a PTFE hose, occurs primarily if the gas is "stored" at pressure in the hose. Most standards limit the amount of permissible permeation.**
- 2.7 Size:** Transmission of power by means of pressurized fluid varies with pressure and rate of flow. The size of the components must be adequate to keep pressure losses to a minimum, and avoid damage due to heat generation or excessive fluid velocity.
- 2.8 Routing: Attention** must be given to optimum routing to minimize inherent problems (kinking or flow restriction due to hose collapse). See SAE AIR1569 for further information.
- 2.9 Environment:** Care must be taken to insure that the hose and fittings are either compatible with or protected from the environment (that is, surrounding conditions) to which they are exposed. Environmental conditions including but not limited to ultraviolet radiation, sunlight, heat, ozone, moisture, water, salt water, chemicals and air pollutants can cause degradation and premature failure.
- 2.10 Mechanical Loads:** External forces can significantly reduce hose life or cause failure. Mechanical loads, which must be considered, include excessive flexing, twist, kinking, tensile or side loads, bend radius, and vibration. Use of swivel type fittings or adapters may be required to insure no twist is put into the hose. Unusual applications may require special testing prior to hose selection.
- 2.11 Physical Damage:** Care must be taken to protect hose from wear, snagging and cutting, which can cause premature hose failure. See SAE ARP1658 for Visual Guide.
- 2.12 Proper End Fitting:** See instructions 3.2 through 3.5 below. Testing to industry standards such as ML-A-5070, AS1339, J517, etc must substantiate these recommendations.
- 2.13 Length:** When establishing a proper hose length, motion absorption, hose length changes due to pressure, and hose and machine tolerances must be considered.

- 2.14 Specifications and Standards:** When selecting hose and fittings, government, industry, and Parker specifications and recommendations must be reviewed and followed as applicable.
- 2.15 Hose Cleanliness:** Hose components may vary in cleanliness levels. Care must be taken to insure that the assembly selected has an adequate level of cleanliness and compatibility for the application. See SAE AS611 for PTFE hose assembly cleanliness levels.
- 2.16 Fire Resistant Fluids:** Some fire resistant fluids require the same hose as petroleum oil. Some use a special hose, while a few fluids will not work with any hose at all. See instructions 2.5 and 1.5. The wrong hose may fail after a very short service. In addition, all liquids but pure water may burn fiercely under certain conditions, and even pure water leakage may be hazardous.
- 2.17 Radiant Heat:** Hose can be heated to destruction without contact by such nearby items as hot manifolds or molten metal. The same heat source may then initiate a fire. This can occur despite the presence of cool air around the hose.
- 2.18 Welding or Brazing:** When using a torch or arc-welder in close proximity to hydraulic lines, the hydraulic lines should be removed or shielded with appropriate fire resistant materials. Flame or weld spatter could burn through the hose and possibly ignite escaping fluid resulting in a catastrophic failure. Heating of plated parts, including hose fittings and adapters, above 450° F (232° C) such as during welding, brazing, or soldering may emit deadly gases.
- 2.19 Atomic Radiation:** Atomic radiation affects all materials used in hose assemblies. Since the long-term effects may be unknown, do not expose hose assemblies to atomic radiation.
- 3.0 HOSE AND FITTING ASSEMBLY AND INSTALLATION INSTRUCTIONS**
- 3.1 Pre-Installation and Periodic Inspection:** Prior to installation, a careful examination of the hose assembly must be performed. All components must be checked for correct style, size, part number, length, and minimum bend radius. In addition, the hose must be examined for cleanliness, broken wires, cuts, kinks, obstructions, blisters, cover looseness, or any other visible defects. Do not use any hose that has any of these conditions. See SAE ARP1658 for illustrations of damage conditions.
- 3.2 Hose and Fitting Assembly:** Do not assemble a Parker fitting on a Parker hose that is not specifically listed by Parker for that fitting unless authorized in writing by the Engineering/Technical Manager or Chief Engineer of the appropriate Parker division. Do not assemble a Parker fitting on another manufacturer's hose or a Parker hose to another manufacturer's fitting unless: (i) the Engineering/Technical Manager or Chief Engineer of the appropriate Parker division approves the assembly in writing, (ii) the user verifies the assembly and the application through analysis and testing or (iii) fabricating MILSPEC assemblies in accordance with proper instructions. See instruction 1.4 above.
- The Parker published instructions must be followed for assembling the fitting on the hose. These instructions are provided in the Parker fitting catalog for the specific Parker industrial fitting being used; most MILSPEC and Aerospace fitting to hose fabrication is closely controlled to authorized facilities.
- 3.3 Related Accessories:** Do not crimp or swage any Parker hose or fittings with anything but the proper listed Parker swage or crimp machine and dies and in accordance with Parker published instructions. Do not crimp or swage another manufacturer's hose fitting with a Parker crimp or swage die unless authorized in writing by the chief engineer of the appropriate Parker division.
- 3.4 Parts:** Do not use any Parker hose fitting part (including but not limited to socket, shell, nipple, or insert) except with the correct Parker mating parts. In accordance with Parker published instructions, unless authorized in writing by the Engineering/Technical Manager or Chief Engineer of the appropriate Parker division. Do not use hose or fitting components from Parker Stratoflex Division with any hose or fitting components from any other Parker Division without this specific authorization. SPD and HPD fitting components shall not be mixed.
- 3.5 Reusable/Permanent:** Do not reuse any reusable fitting product that blew off or pulled off a hose. Do not reuse any fitting component that is cracked or deformed beyond new part tolerance. Do not reuse hose. Do not reuse a Parker permanent (that is, crimped or swaged) hose fitting or any part thereof.
- 3.6 Minimum Bend Radius:** Installation of a hose at less than the minimum listed bend radius may significantly reduce the hose life and cause premature failure. Particular attention must be given to preclude sharp bending at the hose/fitting juncture. If any Stratoflex Products Division hose has been bent to any radius less than its minimum bend radius (minor exceptions from proper authority) or has been kinked during installation, do not use such hose. Such hose is damaged and cannot be used and should be discarded.
- 3.7 Twist Angle and Orientation:** Hose installations must be such that relative motion of machine components does not produce twisting. No twist in the hose is permitted during installation or use. See SAE AIR1569 for additional information.
- 3.8 Securement:** In many applications, it may be necessary to restrain, protect, or guide the hose to protect it from damage by unnecessary flexing, pressure surges, and contact with other mechanical components. Care must be taken to insure such restraints do not introduce additional stress or wear points.
- 3.9 Proper Connection of Ports:** Proper physical installation of the hose requires a correctly installed port connection insuring that no twist or torque is transferred to the hose confirm proper fabrication of the assembly. Gaseous test, including air-under-water, shall be at rated working pressure only and see 4.7 caution below. Care must be exercised to prevent water, or other fluid contaminants from unnecessarily contacting reinforcement, etc.
- 3.10 External Damage:** Proper installation is not complete without insuring that tensile loads, side loads, kinking, flattening, potential abrasion, thread damage, or damage to sealing surfaces are corrected or eliminated. See instruction 2.10.
- 3.11 System Checkout:** All air entrapment must be eliminated (see 4.7) and the system pressurized to the maximum systems pressure and checked for proper function and freedom from leaks. Personnel must stay out of potential hazardous areas while testing and using.
- 3.12 Routing:** Hose should be routed in such a manner so if a failure does occur, oil or fuel mist will not come into contact with hot surfaces, open flame, or sparks, and the chance of personal injury is minimized.
- 4.0 HOSE AND FITTING INSPECTION INSTRUCTIONS**
- 4.1** Even with proper selection and installation, hose life may be significantly reduced without a continuing inspection program. The frequency of inspection should be determined by the system designer or end user taking into account the severity of the application and risk potential. An inspection program must be established and followed by the user and, at minimum, must include instructions 4.2 through 4.7, listed below.
- 4.2 Visual Inspection Hose/Fitting:** Any of the following conditions require immediate shut down and replacement of the hose assembly: (See also ARP1658 for illustrations.)
- Fitting slippage on hose,
 - Damaged, cut or abraded cover (any reinforcement exposed);
 - Hard, stiff, heat cracked, or charred hose;
 - Cracked, damaged, or badly corroded hose or fittings;
 - Leaks at fitting or in hose;
 - Kinked, crushed, flattened or twisted hose; and
 - Blistered, soft, degraded, or loose cover.
- System malfunction including but not limited to, over-pressurization or pressure spikes.
- 4.3 Visual Inspection All Other:** The following items must be tightened, repaired or replaced as required:
- Leaking port conditions;
 - Remove excess dirt buildup;
 - Clamps, guards, shields; and
 - System fluid level, fluid type and any air entrapment.
- 4.4 Functional Test:** Operate the system at maximum operating pressure and check for possible malfunctions and freedom from leaks. Personnel must avoid potential hazardous areas while testing and using the system.
- 4.5 Replacement Intervals:** Specific replacement intervals must be considered based on previous service life, government or industry recommendations, or when failures could result in unacceptable downtime, damage, or injury risk. See instructions 1.2 and 4.2 above.
- 4.6 Inspecting a Pressurized System:** Hydraulic power is accomplished by utilizing high-pressure fluids to do work. Hoses, fittings, and hose assemblies all contribute to doing work by transmitting fluids at high pressures. Fluids under pressure can be dangerous and potentially lethal and, therefore, extreme caution must be exercised when working with fluids under pressure and handling the hoses transporting the fluids. From time to time, hose assemblies will fail. Usually those failures are the result of some form of misapplication, abuse, or simply wear. When hoses fail, generally the high-pressure fluids inside escape in some sort of stream which may or may not be visible to the user. Under no circumstances should the user attempt to locate the leak by "feeling" with their hands or any other part of their body. High-pressure fluids can and will penetrate the skin and cause severe tissue damage and possibly loss of limb. Even seemingly minor hydraulic fluid injection injuries must be treated by a physician with knowledge of the tissue damaging properties of hydraulic fluid.
- If a hose failure occurs, immediately shut down the equipment and leave the area until pressure has been completely released from the hose assembly. Simply shutting down the hydraulic pump may or may not eliminate the pressure in the hose assembly. Many times check valves, etc., are employed in a system and can cause pressure to remain in a hose assembly even when pumps or equipment are not operating. Tiny holes in the hose, commonly known as pinholes, can eject small, dangerously powerful but hard to see streams of hydraulic fluid. It may take several minutes or even hours for the pressure to be relieved so that the hose assembly may be examined safely.
- Once the pressure has been reduced to zero, the hose assembly may be taken off the equipment and examined. It must always be replaced if a failure has occurred. Never attempt to patch or repair a hose assembly that has failed. Consult the nearest Parker distributor or the appropriate Parker division for hose assembly replacement information.
- Never touch or examine a failed hose assembly unless it is obvious that the hose no longer contains fluid under pressure. The high-pressure fluid is extremely dangerous and can cause serious and potentially fatal injury.
- 4.7 Gases:** Special care should be taken when working with gaseous systems. Gases are compressible, thus increase the danger of over-pressure, particularly during test. Sudden escape of gases can cause blindness if the escaping gases contact the eye and can cause freezing or other severe injuries if it contacts any other portion of the body.

Offer of Sale

The items described in this document are hereby offered for sale at prices to be established by Parker Hannifin Corporation, its subsidiaries and its authorized distributors. This offer and its acceptance by any customer ("Buyer") shall be governed by all of the following Terms and Conditions. Buyer's order for any item described in its document, when communicated to Parker Hannifin Corporation, its subsidiary or an authorized distributor ("Seller") verbally or in writing, shall constitute acceptance of this offer.

1. **Terms and Conditions of Sale:** All descriptions, quotations, proposals, offers, acknowledgments, acceptances and sales of Seller's products are subject to and shall be governed exclusively by the terms and conditions stated herein. Buyer's acceptance of any offer to sell is limited to these terms and conditions. Any terms or conditions in addition to, or inconsistent with those stated herein, proposed by Buyer in any acceptance of an offer by Seller, are hereby objected to. No such additional, different or inconsistent terms and conditions shall become part of the contract between Buyer and Seller unless expressly accepted in writing by Seller. Seller's acceptance of any offer to purchase by Buyer is expressly conditional upon Buyer's assent to all the terms and conditions stated herein, including any terms in addition to, or inconsistent with those contained in Buyer's offer. Acceptance of Seller's products shall in all events constitute such assent.

2. **Payment:** Payment shall be made by Buyer net 30 days from the date of delivery of the items purchased hereunder. Any claims by Buyer for omissions or shortages in a shipment shall be waived unless Seller receives notice thereof within 30 days after Buyer's receipt of the shipment.

3. **Delivery:** Unless otherwise provided on the face hereof, delivery shall be made F.O.B. Seller's plant. Regardless of the method of delivery, however, risk of loss shall pass to Buyer upon Seller's delivery to a carrier. Any delivery dates shown are approximate only and Seller shall have no liability for any delays in delivery.

4. **Warranty:** Seller warrants that the items sold hereunder shall be free from defects in material or workmanship for a period of 365 days from the date of shipment to Buyer, or 2,000 hours of use, whichever expires first. THIS WARRANTY COMPRISES THE SOLE AND ENTIRE WARRANTY PERTAINING TO ITEMS PROVIDED HEREUNDER. SELLER MAKES NO OTHER WARRANTY, GUARANTEE, OR REPRESENTATION OF ANY KIND WHATSOEVER. ALL OTHER WARRANTIES, INCLUDING BUT NOT LIMITED TO, MERCHANTABILITY AND FITNESS FOR PURPOSE, WHETHER EXPRESS, IMPLIED, OR ARISING BY OPERATION OF LAW, TRADE USAGE, OR COURSE OF DEALING ARE HEREBY DISCLAIMED. NOTWITHSTANDING THE FOREGOING, THERE ARE NO WARRANTIES WHATSOEVER ON ITEMS BUILT OR ACQUIRED WHOLLY OR PARTIALLY, TO BUYER'S DESIGNS OR SPECIFICATIONS.

5. **Limitation Of Remedy:** SELLER'S LIABILITY ARISING FROM OR IN ANY WAY CONNECTED WITH THE ITEMS SOLD OR THIS CONTRACT SHALL BE LIMITED EXCLUSIVELY TO REPAIR OR REPLACEMENT OF THE ITEMS SOLD OR REFUND OF THE PURCHASE PRICE PAID BY BUYER, AT SELLER'S SOLE OPTION. IN NO EVENT SHALL SELLER BE LIABLE FOR ANY INCIDENTAL, CONSEQUENTIAL OR SPECIAL DAMAGES OF ANY KIND OR NATURE WHATSOEVER, INCLUDING BUT NOT LIMITED TO LOST PROFITS ARISING FROM OR IN ANY WAY CONNECTED WITH THIS AGREEMENT OR ITEMS SOLD HEREUNDER, WHETHER ALLEGED TO ARISE FROM BREACH OF CONTRACT, EXPRESS OR IMPLIED WARRANTY, OR IN TORT, INCLUDING WITHOUT LIMITATION, NEGLIGENCE, FAILURE TO WARN OR STRICT LIABILITY.

6. **Changes, Reschedules and Cancellations:** Buyer may request to modify the designs or specifications for the items sold hereunder as well as the quantities and delivery dates thereof, or may request to cancel all or part of this order, however, no such requested modification or cancellation shall become part of the contract between Buyer and Seller unless accepted by Seller in a written amendment to this Agreement. Acceptance of any such requested modification or cancellation shall be at Seller's discretion, and shall be upon such terms and conditions as Seller may require.

7. **Special Tooling:** A tooling charge may be imposed for any special tooling, including without limitation, dies, fixtures, molds and patterns, acquired to manufacture items sold pursuant to this contract. Such special tooling shall be and remain Seller's property notwithstanding payment of any charges by Buyer. In no event will Buyer acquire any interest in apparatus belonging to Seller which is utilized in the manufacture of the items sold hereunder, even if such apparatus has been specially converted or adapted for such manufacture and notwithstanding any charges paid by Buyer. Unless otherwise agreed, Seller shall have the right to alter, discard or otherwise dispose of any special tooling or other property in its sole discretion at any time.

8. **Buyer's Property:** Any designs, tools, patterns, materials, drawings, confidential information or equipment furnished by Buyer or any other items which become Buyer's property, may be considered obsolete and may be destroyed by Seller after two (2) consecutive years have elapsed without Buyer placing an order for the items which are manufactured using such property. Seller shall not be responsible for any loss or damage to such property while it is in Seller's possession or control.

9. **Taxes:** Unless otherwise indicated on the face hereof, all prices and charges are exclusive of excise, sales, use, property, occupational or like taxes which may be imposed by any taxing authority upon the manufacture, sale or delivery of the items sold hereunder. If any such taxes must be paid by Seller or if Seller is liable for the collection of such tax, the amount thereof shall be in addition to the amounts for the items sold. Buyer agrees to pay all such taxes or to reimburse Seller therefore upon receipt of its invoice. If Buyer claims exemption from any sales, use or other tax imposed by any taxing authority, Buyer shall save Seller harmless from and against any such tax, together with any interest or penalties thereon which may be assessed if the items are held to be taxable.

10. **Indemnity For Infringement of Intellectual Property Rights:** Seller shall have no liability for infringement of any patents, trademarks, copyrights, trade dress, trade secrets or similar rights except as provided in this Part 10. Seller will defend and indemnify Buyer against allegations of infringement of U.S. patents, U.S. trademarks, copyrights, trade dress and trade secrets (hereinafter 'Intellectual Property Rights'). Seller will defend at its expense and will pay the cost of any settlement or damages awarded in an action brought against Buyer based on an allegation that an item sold pursuant to this contract infringes the Intellectual Property Rights of a third party. Seller's obligation to defend and indemnify Buyer is contingent on Buyer notifying Seller within ten (10) days after Buyer becomes aware of such allegations of infringement, and Seller having sole control over the defense of any allegations or actions including all negotiations for settlement or compromise. If an item sold hereunder is subject to a claim that it infringes the Intellectual Property Rights of a third party, Seller may, at its sole expense and option, procure for Buyer the right to continue using said item, replace or modify said item so as to make it noninfringing, or offer to accept return of said item and return the purchase price less a reasonable allowance for depreciation. Notwithstanding the foregoing, Seller shall have no liability for claims of infringement based on information provided by Buyer, or directed to items delivered hereunder for which the designs are specified in whole or part by Buyer, or infringements resulting from the modification, combination or use in a system of any item sold hereunder. The foregoing provisions of this Part 10 shall constitute Seller's sole and exclusive liability and Buyer's sole and exclusive remedy for infringement of Intellectual Property Rights.

If a claim is based on information provided by Buyer or if the design for an item delivered hereunder is specified in whole or in part by Buyer, Buyer shall defend and indemnify Seller for all costs, expenses or judgments resulting from any claim that such item infringes any patent, trademark, copyright, trade dress, trade secret or any similar right.

11. **Force Majeure:** Seller does not assume the risk of and shall not be liable for delay or failure to perform any of Seller's obligations by reason of circumstances beyond the reasonable control of Seller (hereinafter 'events of Force Majeure'). Events of Force Majeure shall include without limitation, accidents, acts of God, strikes or labor disputes, acts, laws, rules or regulations of any government or government agency, fires, floods, delays or failures in delivery of carriers or suppliers, shortages of materials and any other cause beyond Seller's control.

12. **Entire Agreement/Governing Law:** The terms and conditions set forth herein, together with any amendments, modifications and any different terms or conditions expressly accepted by Seller in writing, shall constitute the entire Agreement concerning the items sold, and there are no oral or other representations or agreements which pertain thereto. This Agreement shall be governed in all respects by the law of the State of Ohio. No actions arising out of the sale of the items sold hereunder or this Agreement may be brought by either party more than two (2) years after the cause of action accrues.



3162 PTFE Hose and Fittings

Notes

Stratoflex Products Division Sales Offices

Stratoflex Products Division
Parker Hannifin Corporation
220 Roberts Cut-Off Road
Fort Worth, Texas 76114 U.S.A.
Phone: (817) 738-6543
Fax: (817) 738-9920

Stratoflex Products Division,
Couplings Business Unit
Parker Hannifin Corporation
3800 Calle Tecate
Camarillo, CA 93012 U.S.A.
Phone: (805) 484-8533
Fax: (805) 987-8958

Website: www.parker.com/stratoflex

